



VEDIC SCIENCE

SANKHYA KARIKA



**SANKHYA KARIKA WAS
COMPOSED BY
MAHARISHI KAPILLA &
ITS 68 SUTRAS FORM
THE CORE OF THE
BHAGAVAD GITA IN
CHAPTER TWO**

**SECRET OF SANKHYA:
ACME OF SCIENTIFIC
UNIFICATION.**

DECODED BY *G SRINIVASAN*

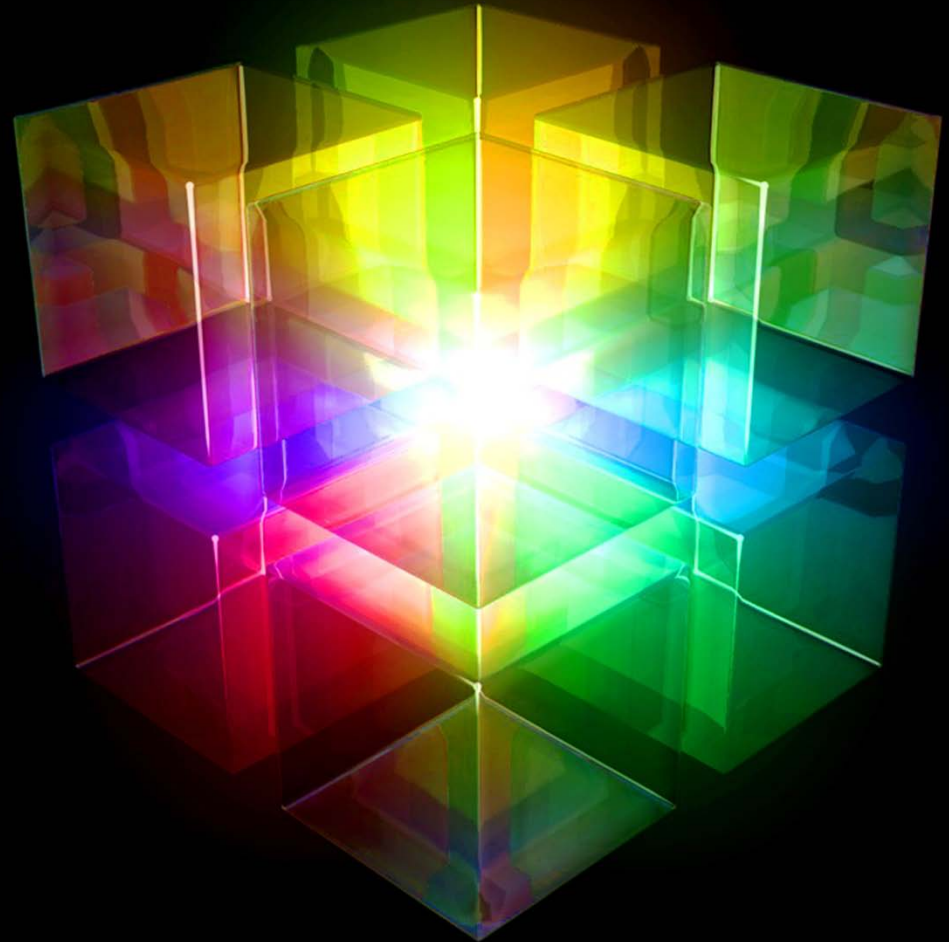

THEORY OF UNIVERSAL MANIFESTATION

LOGIC OF SANKHYA KARIKA



ACME OF SCIENTIFIC UNIFICATION;

BASED ON AXIOMATIC LOGIC;

IS SELF-SIMILAR & SCALE INVARIANT;

USES COMBINATORIAL MATHEMATICS;

ALL DERIVATIONS FROM BASICS;

INTERNAL PROOF BASED ON AXIOMS.

SPACE COMPRISES



DYNAMIC COMPONENTS,

DEFINED DIMENSIONALLY,

IN PERPETUAL OSCILLATORY STATE,

PROVIDES THE HOLOGRAPHIC BASE,

TO CREATE ALL PHENOMENA

DYNAMIC STATES OF SPACE

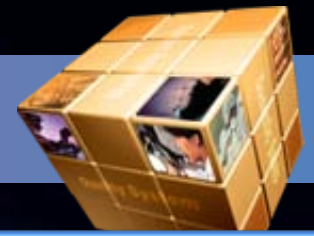

SUTRA 1 In Sanskrit & means:

AIKANTHA dense & coherent

ATHYANTHA resonant & harmonic

ATHO expansive & radiant

ABHAVATH unmanifest or undetectable

INTERACTIVE CYCLE



SUTRA 3 : PIVOTAL THEOREM DEFINING PERPETUAL HARMONIC OSCILLATORY STATE. (PHO)

DUKHA TRAYA ABHIGHATA

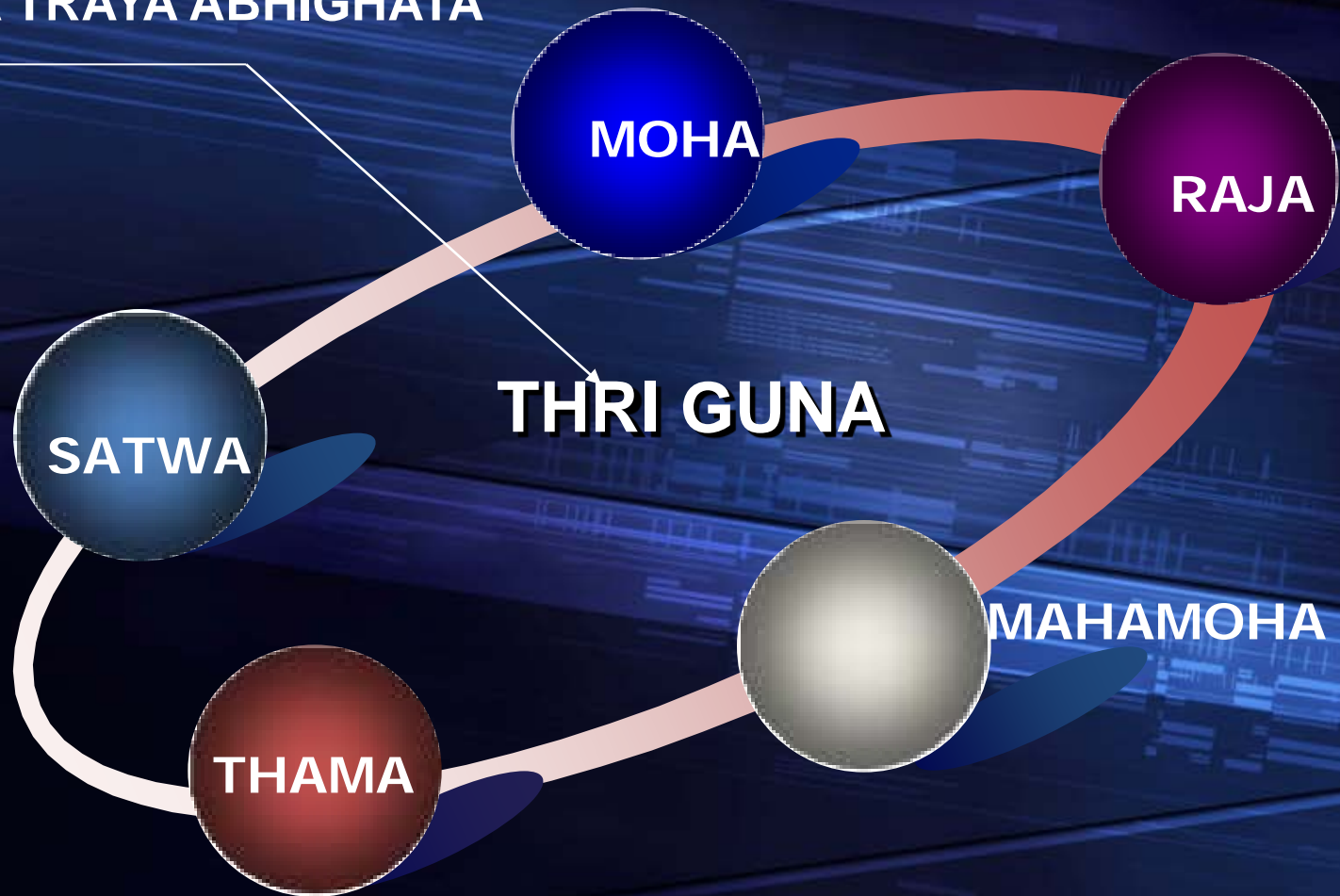

INTERACTIVE MODES



INTERACTIVE STRESS IN THREE MODES IN THE PHO STATE

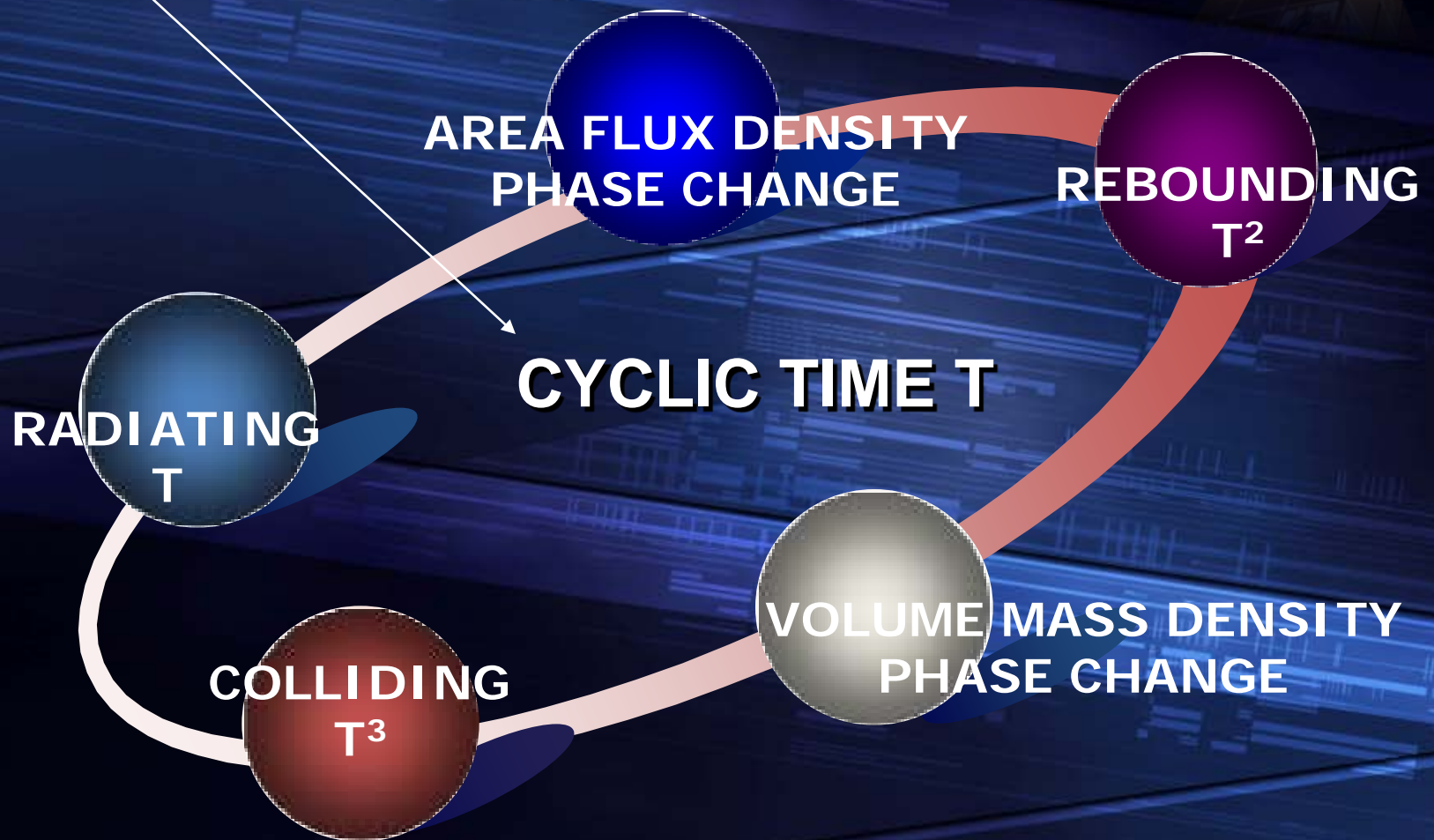

CONCEPT OF SIMULTANEITY



CONCEPT OF MOOLAPRAKRITHI

CENTRE OF IMPACT

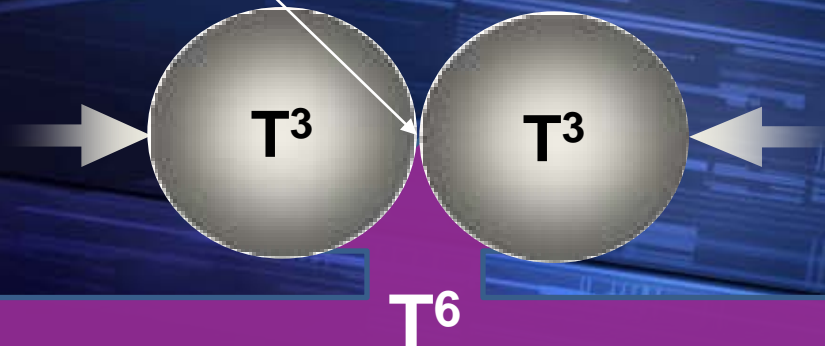

INSTANT OF SIMULTANEOUS ACTION.
 T^6 IS THE EVENT THAT ENABLES COUNTING OF
INTERACTIONS

PHO STATE (*SUTRAS 15 TO 22*)

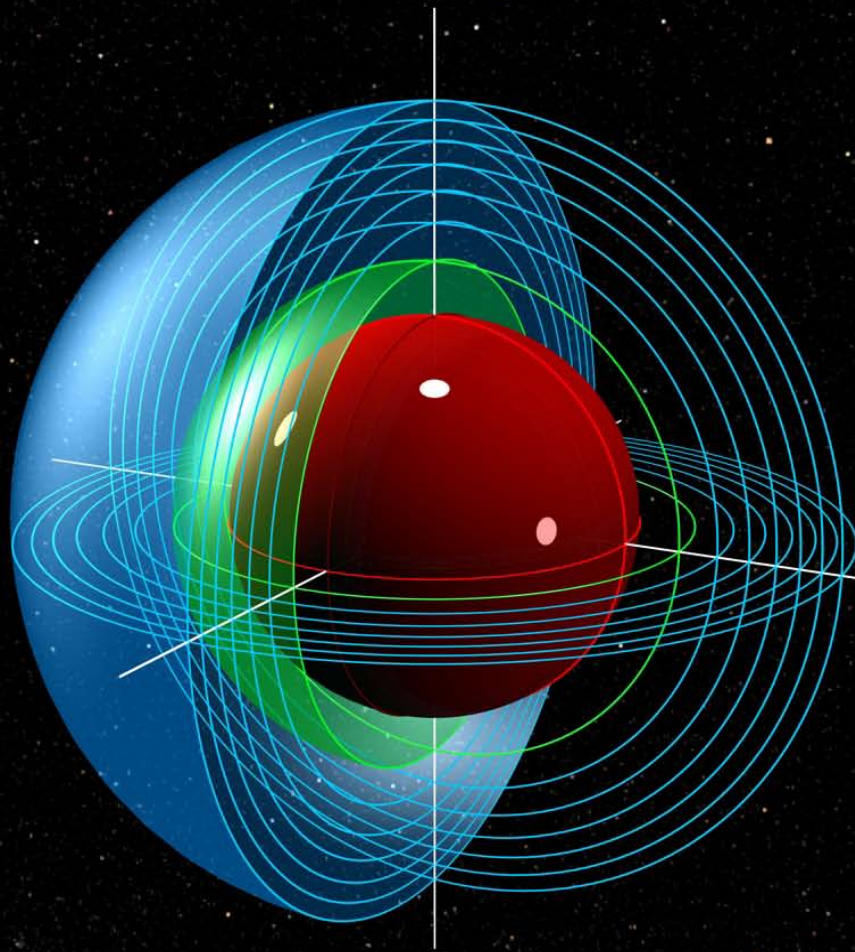

RED=DENSITY 2. HADRONS
(STATE)

GREEN= DENSITY 1. BOSONS
(STATE)

BLUE= DENSITY .5 to .125.
LEPTONS (STATE)

The expanded leptonic states extend from the electron to seven neutrino levels. When the seven radiate simultaneously it attains the photon state.

Displays single unified law of dynamic interactions in space.

Applies to all bodies like Galaxy, stellar, planetary, molecular, atomic and subatomic particle states.

DYNAMIC CYCLES IN SPACE



- 1 Moolaprakrithi (new)
- 2 Vrithi Photon
- 3 Vikharo Neutrino
- 4 Vikrithi Lepton
- 5 Prakrithi Hadron
- 6 Mahad Quarks

COHERENT STATE IN SPACE



8

PURUSHA (Planckmass)

COHERENT STATE AT MAXIMUM STRESS POTENTIAL.



CENTRED MASS DISPLAYS UNIT COUNT = GROUND STATE



STRESSES MIGRATE TOWARDS THIS GROUND STATE



FUNDAMENTAL CAUSE OF GRAVITATION (NEW CONCEPT)

MOOLAPRAKRITHI

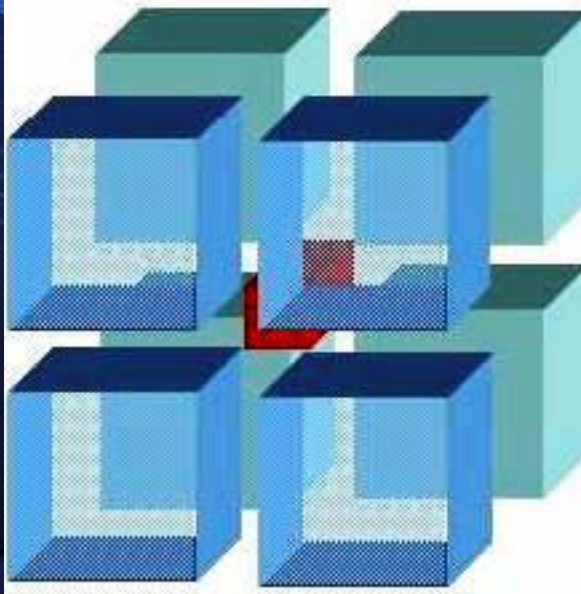
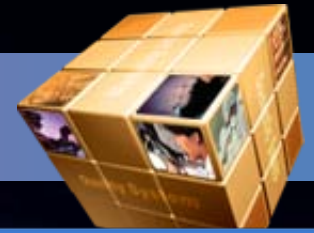

ROOT OSCILLATORY STATE .

THE RED CUBE BETWEEN 8 BLUE CUBES.

THE ELEMENTAL INTERACTIVE INTERVAL

IT SEPARATES THE RESONANT STATE

FROM THE COHERENT STATE.

TRANSMIGRATES AS STRESSES IN SPACE AND CANNOT BE DETECTED

ALL PHENOMENA CAN BE DEFINED AS NUMBERS OF IT.

RELATIVE MASS OF 1.34×10^{-51} . NEW TO PHYSICS

VRITHI

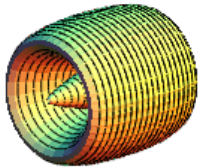

A Vortex of Moolaprakritis = quanta

Coherent state of merged stresses.

Acceleration of Vrithis = Vikharo states

7 Vikharo = Photon in Physics. (Planck's Constant)

Transmigrates at a constant oscillatory rate.

Many Quanta transmigrate simultaneously

Quantum of self-sustaining interactive stress

VIKHARO

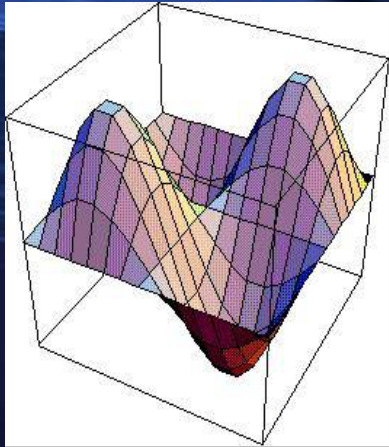

Process of transmigration of stresses.

Transmigration commences when the-

Resonant interactive cycle is broken.

Neutrino in Physics

1 to 7 units transmigrate by tunneling.

Above 7 it transmigrates as radiant Vrithis.

Photons = 7 Vrithis units in a coherent state.

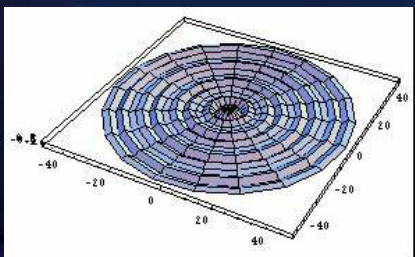
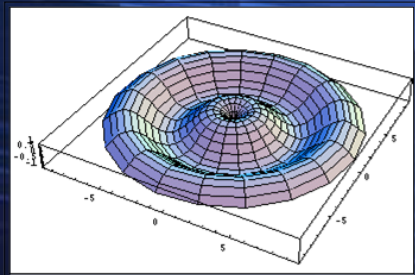

Interactive Harmonic states.

Outer Nuclear boundary

Lepton state

Electron state at first harmonic level

Spectrum of 7 levels repeat periodically .

In Physics the Hydrogen spectrum level

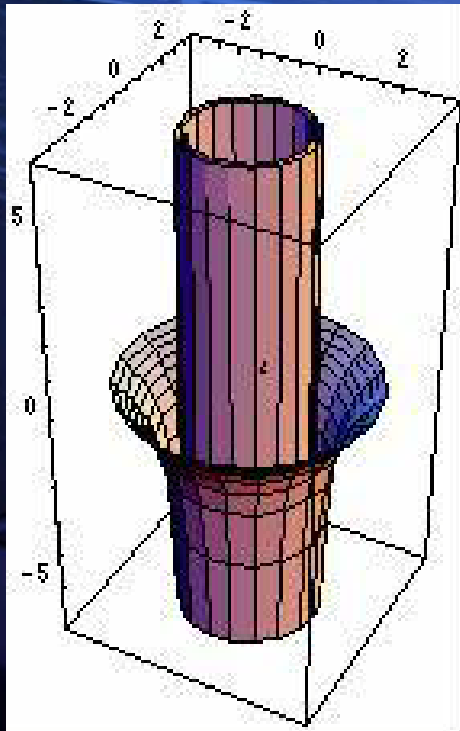

Hadrons .

Resonant nuclear state.

Nuclear inner coherent surface.

Proton in Physics.

Inner surface density of 2.

Perpetual harmonic oscillation.

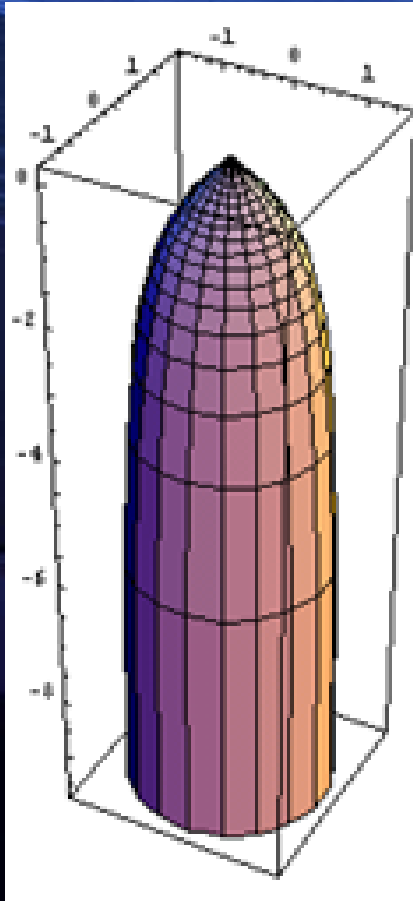

Quarks state.

The merged dense black hole state

Core stress density of 18 orders

Simultaneous interactive state

Transition boundary to Purusha

Planck mass & density at peak

PURUSHA

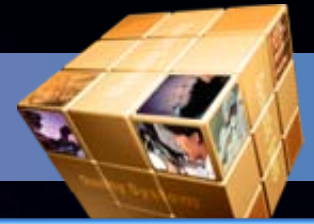

Coherent state .

Maximum coherent potential.

Perpetual simultaneous interactions.

Stresses merge to unity count.

Forms 'negative' ground state.

Initiates gravitational acceleration.

Sum of all odd & even harmonics

Unity state = .91459 mass unit.

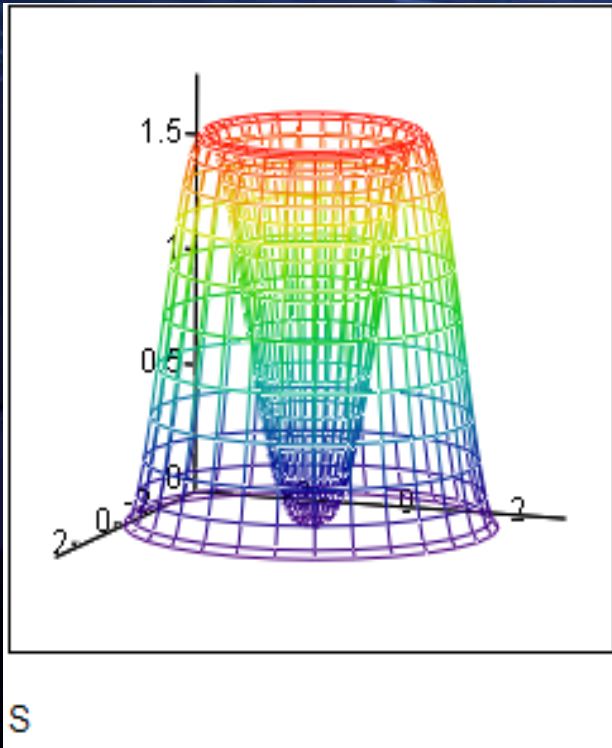

MOOLAPRAKRITHI UNIFIES

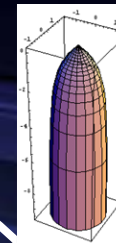
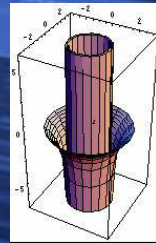

PRAKRITHI = HADRON
 C^4

MAHAD = QUARK
 C^5

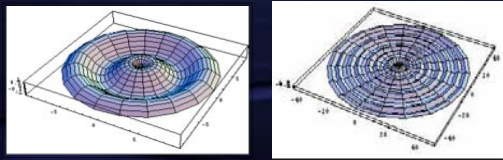

VIKRITHI = LEPTON
 C^3
(SPECTRUM OF 7)

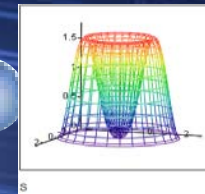

PURUSHA = P'MASS
 C^6

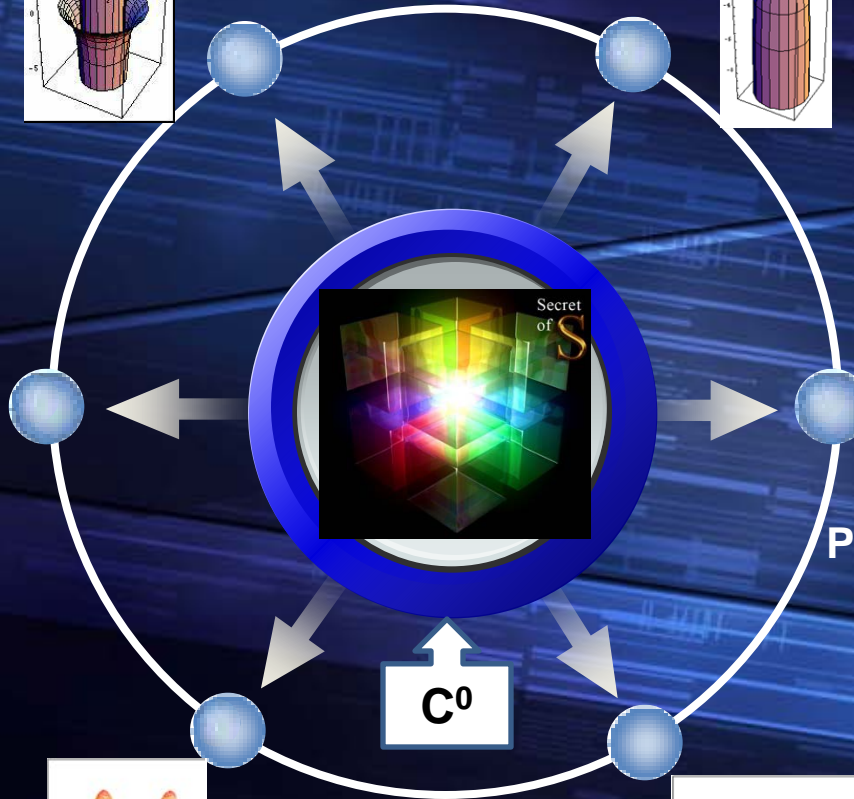

VIKHARO = NEUTRINO
 C^2

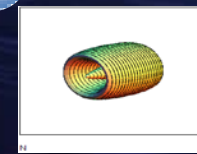
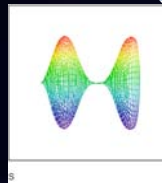

VRITHI = STRESS VORTEX
 C^1

PHOTON = 7 VIKHAROS

COHERENT FORMS IN SPACE

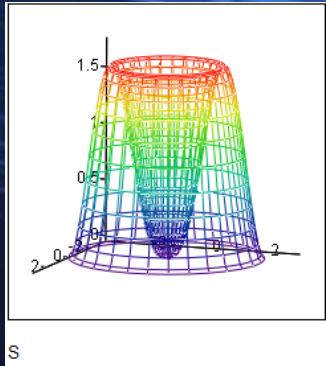

S

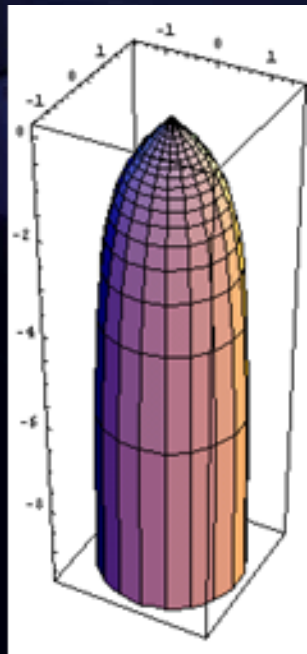

PERPETUALLY INTERACTIVE

MAXIMUM STRESS DENSITY

STRESSES MERGE TO UNITY-COUNT

ACTS AS ONE CENTRED MASS

STRESS GRAVITATE TO CENTRE

UNDETECTABLE DIRECTLY

REACTIONS DETECTABLE

STRESSES IN 'SOLID' STATE.

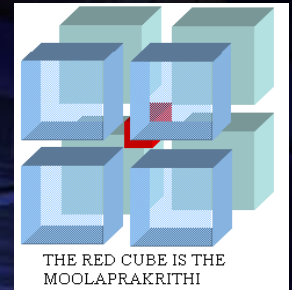

THE RED CUBE IS THE MOOLAPRAKRITHI

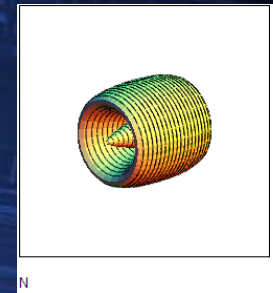

N

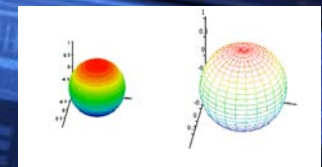

(X,Y,Z)

(X,Y,Z)

RESONANT FORMS IN SPACE

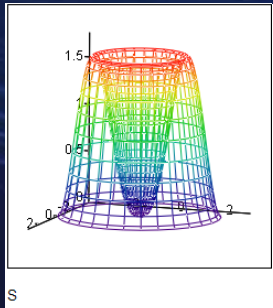

HARMONICALLY INTERACTIVE

RESONANT GROUND STATE

CONSTANT OSCILLATORY RATE

TWIN OSCILLATORY BOUNDARIES.

INNER LIMIT TWICE STRESS COUNT

OUTER LIMIT HALF STRESS COUNT

STRESSES CONTAINED

STRESSES IN 'FLUID' STATE

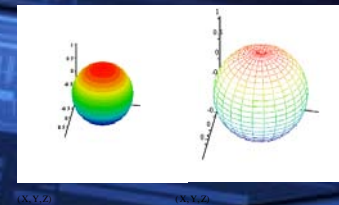
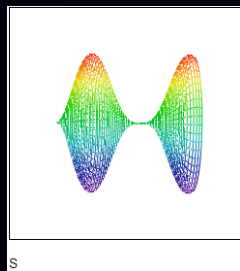
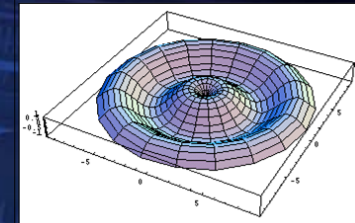
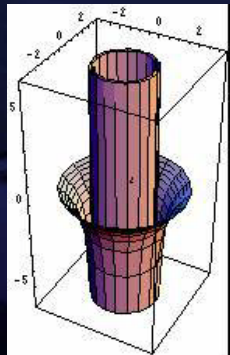
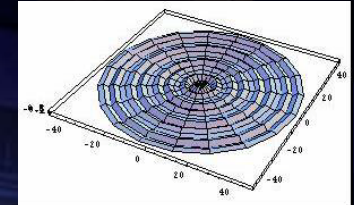

QUANTUM MIGRATION IN SPACE



EXPANSIVE TRANSMIGRATION AS QUANTA

THREE MODES OF TRANSMIGRATION

SIMULTANEOUS MIGRATION AS FLUX QUANTA

RESONANT MIGRATION AS QUANTUM

RADIANT TRANSMIGRATION ABOVE 7 QUANTA

MIGRATE PERPETUALLY TO UNITY COUNT

GROUND STATE ABSORBS HIGHER RATE

STRESS IMPULSE TUNNEL INSTANTLY

STRESSES IN 'VAPOUR' STATE

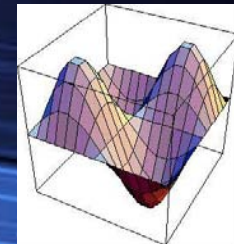
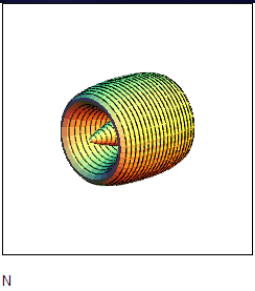
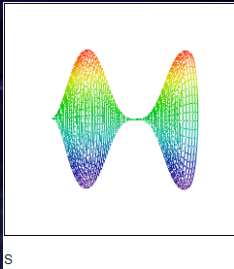
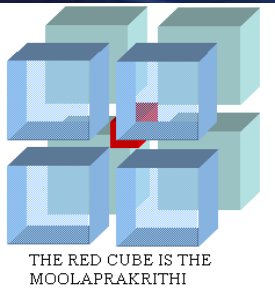

GRAVITATION



Total Unification

Purusha: coherent state provides the ground state.

Maximum stress density merges into a unity count.

Higher count rate gravitate towards unity count.

The centered coherent state initiates gravitation.

All other forces too transmigrate to a lower count.

Nuclear, Weak and EMW act in its own 'time'

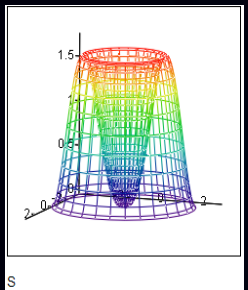
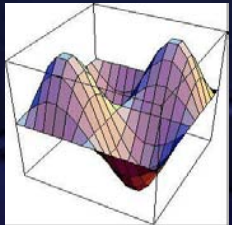
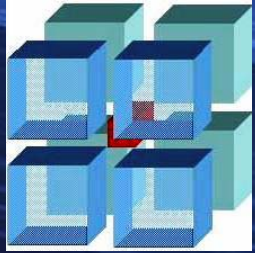

DERIVATION OF GRAVITATION

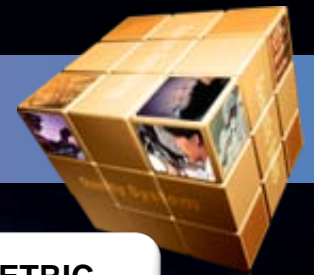

CONCEPT OF INTERACTIVE COUNT REDUCTION WHEN TWO DYNAMIC VOLUMETRIC STATES OF SPACE MERGE TO BECOME A SINGLE OSCILLATORY HOLOGRAPHIC STATE WITH A SINGLE CENTRE OF PHO ACTIVITY IN SPACE

CENTRE OF MASS

PHO STRESS ACTING SIMULTANEOUSLY TOWARDS CENTRE REPRESENTING SINGLE MERGED BUT MASSIVE COUNT

CENTRE OF SIMULTANEOUS ACTION

$$T^6 / T^4 = T^2$$

GRAVITY CONSTANT

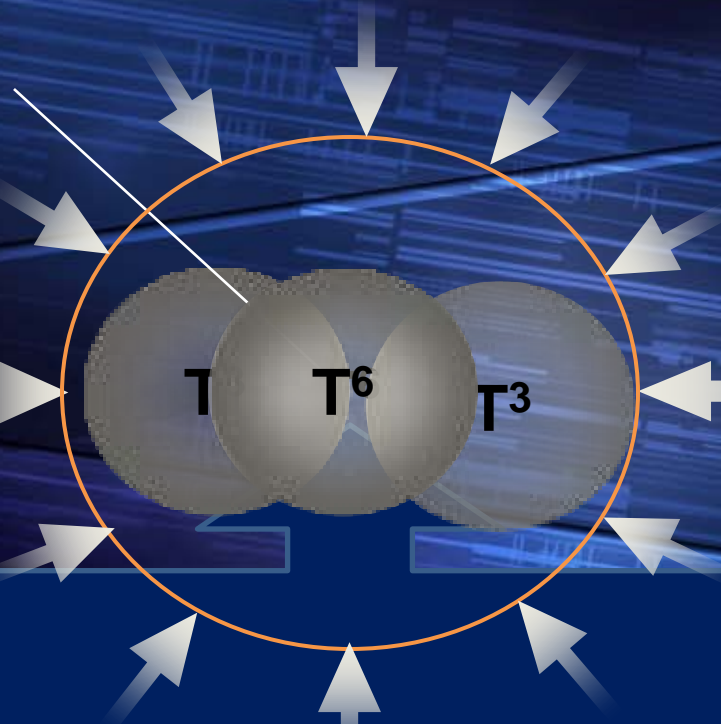

GRAVITATIONAL SPECTRUM



RESONANT SOLAR PLANETARY SPECTRUM AS PROOF

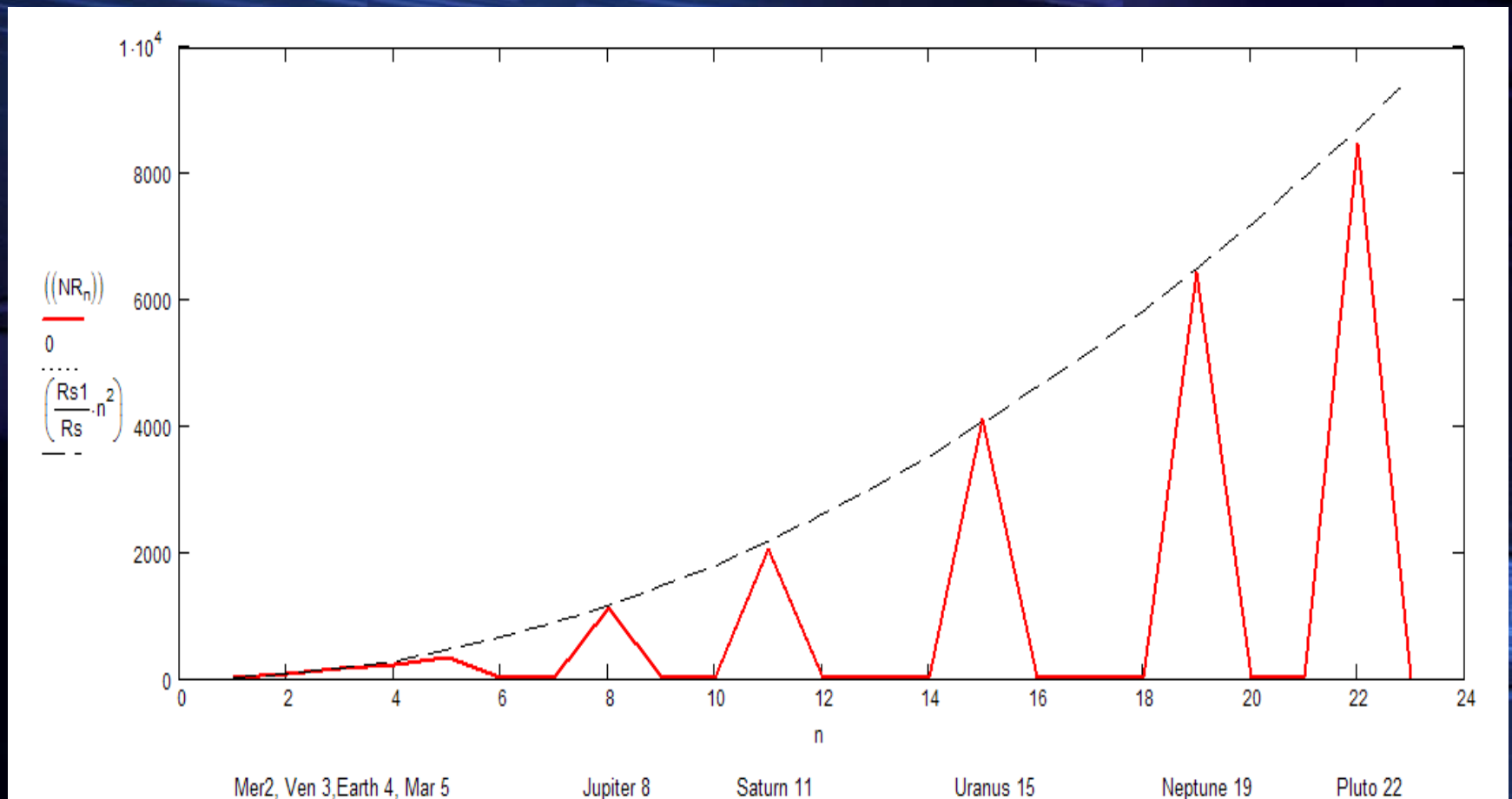

UNIFICATION



WHAT IS "ACME OF SCIENTIFIC UNIFICATION" ?

When all the operative parameters in a three dimensional continuum as space are made proportional to one variable dimensionless ratio then the solutions to any or all formulation in it depend only on that single ratio.

In Sankhya the single dimensionless ratio is the interval as "time" separating two interactions or axiomatic cyclic events.

If this interval as time is less than the duration of the cyclic event the ratio is defined as being simultaneous (merged).

If the time is greater than the duration of that cyclic event then it is defined as sequential or separate or frequent.

AXIOMATIC LOGIC



EXPLANATION OF "BASED ON AXIOMATIC LOGIC":

AXIOM CANNOT BE DISPROVED

**ANY OPERATIVE PARAMATER OR EVENT'S NUMERICAL VALUE
BASED ON NUMERICAL AXIOMS ATTAINS PERMANENT VALIDITY
AND LOGICAL CONTINUITY.**

**ALL FORMULATIONS BASED ON SUCH A DERIVATION CANNOT BE
DISPROVED AND MUST BE ACCEPTED AS A LOGICAL EXTENSION
OF THAT VALUE AND IS CORRECT.**

SELF-SIMILARITY



DEFINITION OF "SELF-SIMILARITY AND SCALE INVARIANCE"

SELF-SIMILARITY IS THE PROPERTY OF BEING EXACTLY PROPORTIONAL TO A PART OF ITSELF IN NUMERICAL TERMS.

SCALE INVARIANCE IS AN EXACT FORM OF SELF-SIMILARITY WHERE AT ANY MAGNIFICATION THERE IS AN EXACT PROPORTIONAL VALUE OF THE ORIGINAL.

THE NUMERICAL VALUE THAT IS EXACTLY SELF SIMILAR IS $X=0.618034$ AND IS SHOWN BELOW.

$$X = 0.6180339887$$

$$X + X^2 = 1 \quad X^2 + X^3 \cdot 2 + X^4 = 1 \quad X^3 + X^4 \cdot 3 + X^5 \cdot 3 + X^6 = 1$$

COMBINATORIAL MATHEMATICS



THE MATHEMATICAL OPERATIONS ARE CONDUCTED BY USING THE PRINCIPLES OF COMBINATORIAL MATHEMATICS.

COMBINATORIAL MATHEMATICS ALSO CALLED THE PRINCIPLE OF COUNTING FINITE / DISCRETE EVENTS, CYCLES & STRUCTURES PROVIDES EXTREME NUMERICAL ACCURACY.

ITS LEVEL OF ACCURACY EQUALS THE UNIT DISCRETE VALUE DERIVED FOR THE FORMULATED OPERATION

AXIOMATIC DERIVATION



ALL DERIVATIONS ARE FROM BASICS.

EVERY MATHEMATICAL FORMULATION IS BASED ON A VALUE DERIVED THROUGH AXIOMS AT THE BASIC OR FIRST LEVEL .

HENCE THE FORMULATION DOES NOT NEED NOR IS IT BASED ON ARBITRARY CONSTANTS OR EXPERIMENTALLY MEASURED VALUES OR EMPIRICAL DERIVATIONS.

INTERNAL PROOF



INTERNAL PROOF IS BASED ON AXIOMS.

THE PROOF IS BASED ON THE PRINCIPLE OF SELF-SIMILARITY AND SCALE INVARIANCE.

IN ANY INTERACTION OF VOLUMETRIC STATES THE POINT OF COLLISION CAN ONLY RISE TO A SIMULTANEOUS LIMIT OF 6 ORDERS OF LEVEL.

UNEQUIVOCAL INTERNAL PROOF IS ESTABLISHED IF ALL THE FACTORS INVOLVED IN BETWEEN THE 6 ORDERS OF LEVEL IS EQUATED WITH AN ERROR SMALLER THAN THE SMALLEST DISCRETE UNIT COUNT.

SEE SLIDE 19 WHERE PROOF IS GIVEN TO A LEVEL OF ACCURACY OF ONE MOOLAPRAKRITI VALUE

HOLISTIC THEORY



ENTIRE SPECTRUM OF MANIFESTATION BOTH VISIBLE AND HIDDEN

LIFE SCIENCES: ORGANIC, INORGANIC, GENETICS, TRANSMIGRATION OF LIFE

COSMIC SCIENCES:: ASTROPHYSICS, ASTROLOGY,, ESP, DISASTER PREDICTION .

LIVING PROCESS:: AYURVEDA, EDUCATION, ARCHITECTURE, ENGINEERING, ARTS, CRAFTS,

COMPLETE SPECTRUM OF HOLOGRAPHIC STATES



Hologram (Sanskrit)	Sankhya Value Symbol	Physics (equivalent)	Stress Density level.	PHO state
Andhatamishra	Kx	None (blackhole)	HD Stress centre of mass	Simultaneous (third order damping)
Mahad	Mps	Hadrons	Density transition with change in volume	Coherent
Prakrithi	PM	Nucleon	Dense Stress Volume at core	transition
Vikrithi	Me	Lepton	Stress at Boundary of Nuclear volume	Resonant
Vrithi	Ne	Neutrino	Stress quantum at unit volume and density	transition
Vikharo	7 Ne	Photon	Radiant stress quanta of 7 states	Radiant or expansive
Moola-prakrithy	My	None	T'migration stress UNIT	Sequential Interactive state

AXIOMATIC EQUATION OF OSCILLATORY STATE. PHO



TAMA = RAJA + SATVA

$$\frac{\text{MAHAD} - \text{PRAKRIT}}{\text{PRAKRITI} - \text{VIKRITI}} = \frac{7 + \frac{1}{7}}{2} = \frac{\text{VIKRITISAPTA} - \text{VRITHI}}{\text{VRITHI} - \text{VIKHARO}}$$

$$\frac{\text{PM} - \text{Pm}}{\text{Pn} - \text{PM}} = \frac{7 + \frac{1}{7}}{2} = \frac{\text{Mep} - \text{Me}}{(\text{Me} - \text{Mee}) \cdot 2^{\frac{1}{3}}} = 1$$

$$\frac{\text{boson} - \text{Proton}}{\text{Neutron} - \text{boson}} = \frac{7 + \frac{1}{7}}{2} = \frac{\text{Muon} - \text{Meson}}{(\text{Meson} - \text{Electron}) \cdot 2^{\frac{1}{3}}} = 1$$

PM = BOSON STATE. Pn = NEUTRON STATE. Pm = PROTON STATE

Me = MESON STATE. Mep = MUON STATE . Mee = ELECTRON STATE

ENERGY EXTRACTION FROM SPACE

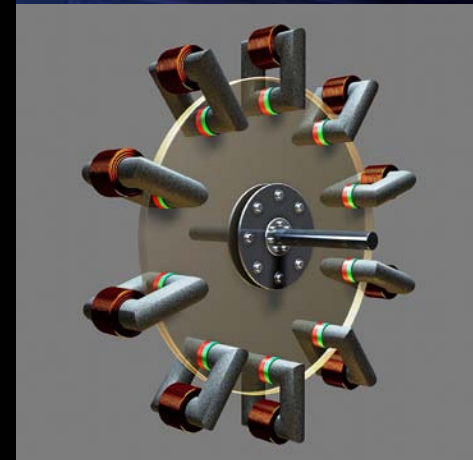

Sutra 37 derives the process of extracting energy from space field through triggered impulses. Concept model above is under trial presently with 10 coils and 10 magnets.

SANKHYA KARIKA



Secret
of

Sankhya

by G. Srinivasan

Acme of Scientific Unification

Sankhya is the most astounding scientific theory derived merely through intellectual deduction based on axioms. It derives and defines all phenomena logically, mathematically, accurately and completely using just one principle: the three modes of variation of time in any cyclic activity. Despite its purely intellectual foundation it is more accurate and comprehensive than modern Physics and Cosmology. Sankhya has succeeded because it defines and describes space as being substantial and perpetually dynamic, unlike the current concept in Physics that space is a void in a vacuum state.

Thank You !

<http://sankhyakarika.webstarts.com/?r=2012021408>